



products with a watertight reputation

DIGITAL MEDIA LOCKER™

AQ-DM-4UBT

OWNERS MANUAL

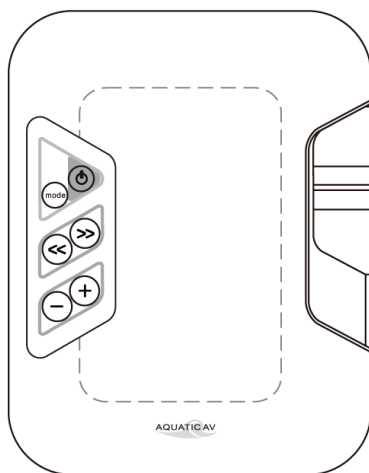

AQ-DM-4UBT

DIGITAL MEDIA LOCKER™

for Bluetooth, USB, iPod, iPhone & MP3 devices



PLEASE READ THIS INSTRUCTION MANUAL BEFORE INSTALLATION
AND OPERATION

CONTENTS

- AQ-DM-4UBT Digital Media Locker™
- 2-Way RF Wireless Remote Control (AQ-RFDM-4)
- USB to 30-pin iPod™ Cable
- 3.5mm to 3.5mm Jack Cable
- Wiring Harness (AQ-UNH-2)
- Six (6) Stainless Steel Mounting Screws
- One (1) CR-2430 Battery
- Mounting Template
- Owners Manual

INSTALLATION

1. 12-pin Watertight Harness

The 12-pin harness supplies power and ground connections to the Digital Media Locker and four (4) speaker channel output connections from the Digital Media Locker.



Do not cut or modify the 12-pin harness on the Locker side or warranty will be void.

2. FM Radio Antenna Jack

Connect antenna (AQ-ANT-1 sold separately) to female antenna receptacle. For best FM performance make sure the antenna is extended to the highest achievable position.

3. Auxiliary Inputs

Provides RCA input for connecting other auxiliary audio devices.

4. Auxiliary Outputs

Allows external amplifiers to be connected to power additional speakers.

5. 12V DC External Trigger

Allows for an external light or relay to be triggered (350mA max load).

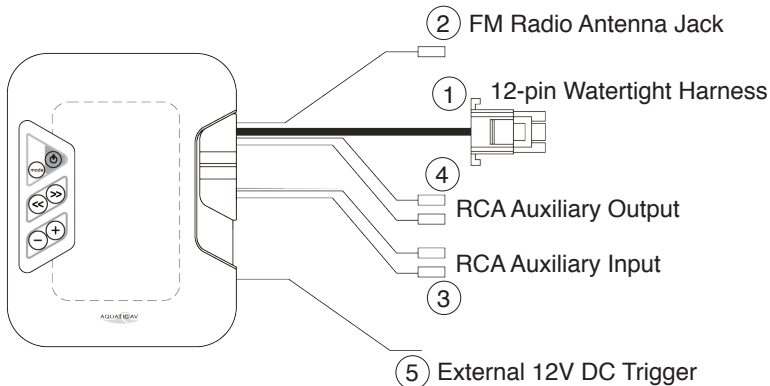

12-PIN HARNESS CONNECTION

The AQ-DM-4UBT includes the universal harness AQ-UNH-2 in order to connect the dock to power and speakers.

All open wire connections should be soldered and protected against water and dust for best long term performance.

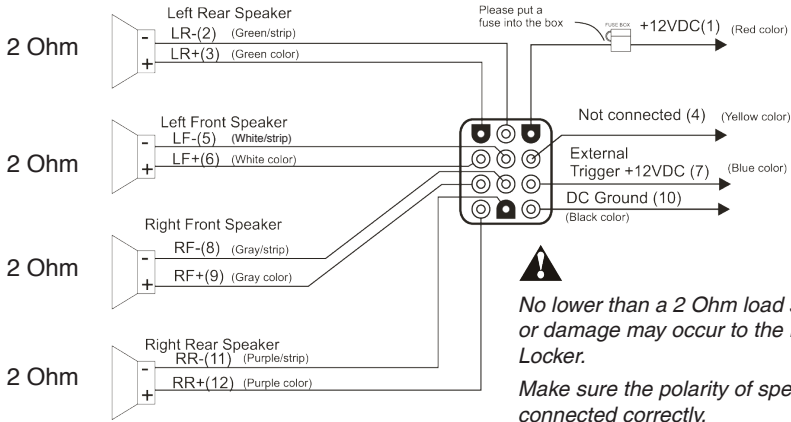

MOUNTING THE UNIT

1. Mounting templates are included. Aquatic AV recommends using the 'measure twice, cut once' method.
2. Once the mounting hole is complete, make sure the outside surface is clean and clear of debris. The Digital Media Locker has an external water/dust proof gasket, but this requires a clean surface for best performance.
3. The Digital Media Locker has six (6) front screws. Drive the screws using a screw driver. During final mounting apply equal pressure to all points for the best water/dust outer seal performance.
4. Review all outside surfaces of the Digital Media Locker to ensure proper water/dust seal. This is important for long term environmental protection performance for your digital media device.

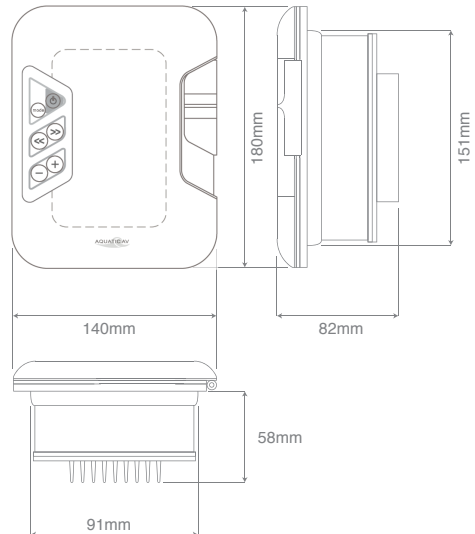

REMOTE BATTERY INSTALL

Remove the RF Wireless Remote control from the Digital Media Locker. Unscrew the waterproof cap on the back of the remote control. Place the CR-2430 battery in the RF Remote control and replace the water/dust proof cap.



POWER ON

Press the on/off button. ON will be indicated by a red LED.

For applications that require zero current draw, and where battery drain may occur, the power button must be turned OFF. When the power button is in the OFF position the red LED will not be lit.

For applications where a 12V battery is not used, such as in a Spa, the power button can be left ON and the remote control can then be used to power on/off accordingly.

REMOTE SYNCHRONIZING

1. Turn the docking station OFF with the on/off button inside the door (the red LED should not be illuminated when power is OFF).
2. Press the red  (POWER) button on the remote.
3. Press and hold the  (MODE) button until the LCD reads PAIR.
4. Continue to press the MODE button during step 5 below.
5. Turn the docking station ON (within 10 seconds) with the on/off button inside door (the red LED will illuminate when power is ON).
6. The remote's LCD should read WELCOME or show a mode position such as RADIO, IPOD, or AUX IN.

For any additional remote controls, you will also need to activate/synchronize those remote controls by following the steps above.



If the pairing process is not effective, switch the locker off using the on/off button located inside the door of the dock. Unplug the 12-pin Harness on the back of the Locker for 3 minutes. Reattach the Harness and repeat steps 1-6 above.



If the LCD displays "- -" in either mode, this means the remote is out of reception range. Move the remote closer to the Locker and try again.



If you loose your remote control and buy another new remote control, please follow the above to start pairing before normal usage.

DIGITAL MEDIA LOCKER

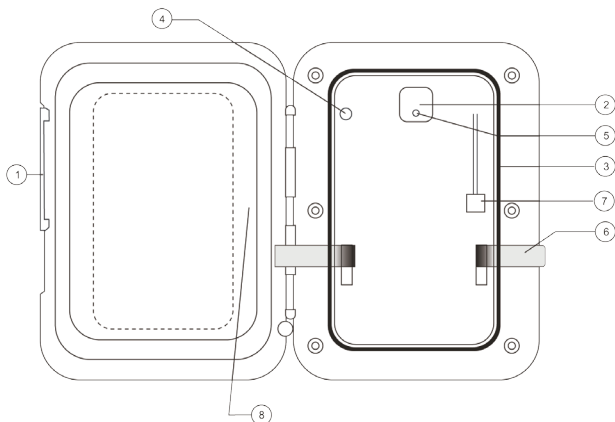

1. Digital Media Locker Open/Close Latch & Protective Door
2. Power ON/OFF Button
3. Water/Dust Protection Inner Gasket
4. 3.5mm Aux Input for MP3 Devices
5. Power ON/OFF LED
6. Security Strap for digital media devices
7. USB Connector
8. Door Control Keypad

DOOR CONTROL KEYPAD

Buttons		Music Mode	FM Radio Mode
Power		Press once: Toggle from Operation mode to Standby mode or vice-versa.	
Mode		Press once: Change the source. Press and hold: Pair	Press once: Change the source. Press and hold: Pair
Volume Up		Press once: Volume up Press and hold: Fast volume up	Press once: Volume up Press and hold: Fast volume up
Volume Down		Press once: Volume down Press and hold: Fast volume down	Press once: Volume down Press and hold: Fast volume down
Play / Pause		Press once: Play/Pause Press and hold: Play/Pause	Press once: Toggle mute Press and hold: Toggle mute
Fast Rewind		Press once: Previous track Press and hold: Fast rewind	Press once: Seek down Press and hold: Toggle manual scanning
Fast Forward		Press once: Next track Press and hold: Fast forward	Press once: Seek up Press and hold: Toggle to manual scanning

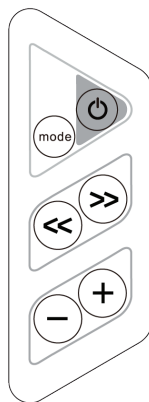

i The keypad on the door has a set of keys fewer than those on the remote but has exactly the same functions correspondingly. This keypad allows you to operate the dock even under no remote condition.

REMOTE CONTROL

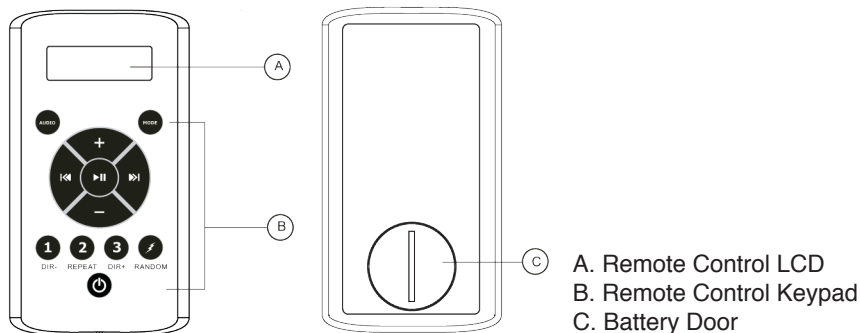

A. Remote Control LCD
 B. Remote Control Keypad
 C. Battery Door



Buttons		Music Mode	FM Radio Mode
Power		Press once: Toggle from Operation mode to Standby mode or vice-versa.	
Mode		Press once: Change the source. Press and hold: Pair	Press once: Change the source. Press and hold: Pair
Audio		Press once: Enter BAS-TRE-BAL-FAD-DX-MONO-STEREO Press and hold: Toggle USA to Euro tuning	Press once: Enter BAS-TRE-BAL-FAD-DX-MONO-STEREO Press and hold: Toggle USA to Euro tuning
Volume Up		Press once: Volume up Press and hold: Fast volume up	Press once: Volume up Press and hold: Fast volume up
Volume Down		Press once: Volume down Press and hold: Fast volume down	Press once: Volume down Press and hold: Fast volume down
Play / Pause		Press once: Play/Pause Press and hold: Play/Pause	Press once: Toggle mute Press and hold: Toggle mute
Fast Rewind		Press once: Previous track Press and hold: Fast rewind	Press once: Seek down Press and hold: Toggle manual scanning
Fast Forward		Press once: Next track Press and hold: Fast forward	Press once: Seek up Press and hold: Toggle to manual scanning
1 / DIR -		Press once: Back to previous folder Press and hold: Back to previous folder	Press once: Listen to FM preset station 1 Press and hold: Set preset FM station 1
2 / Repeat		Press once: Repeat function Press and hold: Repeat function	Press once: Listen to FM preset station 2 Press and hold: Set preset FM station 2
3 / DIR +		Press once: Forward to next folder Press and hold: Forward to next folder	Press once: Listen to FM preset station 3 Press and hold: Set preset FM station 3
12V Trigger / Random		Press once: Random playback function Press and hold: Toggle external 12V power on/off	Press once: No function Press and hold: Toggle external 12V power on/off

i If your music player is connected via the Auxiliary input you will not be able to control track or receive track information.

i In order to prolong remote battery life the LCD will shut off in 20 seconds if no other button is pressed. To turn remote back on press any key once and then press the command desired.

i Turn off DSP to access control of Bass and Treble

LISTENING VIA USB

1. Power up the Digital Media Locker
2. Attach your device to the USB cable inside the Digital Media Locker using the appropriate USB adaptor.
3. Secure the device with the anchor straps provided.
4. Secure the Digital Media Locker's protective door.
5. Press  (POWER) on the remote control or Power button on the locker to turn it ON.
6. Press  (Mode) on the remote control to select USB mode. Use the buttons as shown in the remote function chart.







Always ensure to connect and disconnect your media player with dry hands!

LISTENING VIA 3.5MM JACK

1. Power up the Digital Media Locker.
2. Attach your MP3 device to the 3.5mm connector.
3. Secure the device with the anchor straps provided.
4. Secure the Digital Media Locker's protective door.
5. Press  (Mode) on the remote control to select 'AUX IN' mode.

ADJUST VOLUME LEVEL

1. Press  (VOLUME UP) once to increase the volume by 3 decibels.
2. Press  (VOLUME DOWN) once to reduce the volume by 3 decibels.
3. Press and hold either  or  and the Digital Media Locker will increase or decrease audio volume continuously.





ENTER FM RADIO MODE

1. Press  (MODE) on remote control to switch to FM radio mode.



 *If this is the first time you listen to FM radio, the default frequency will be 87.5MHz, as shown on the remote LCD.*

 *FM radio is only available when you are in the FM Radio mode.*

TO SCAN OR NAVIGATE CHANNELS

1. Press  (FAST REWIND) or  (FAST FORWARD) to seek another station.
2. Press and hold either  (FAST REWIND) or  (FAST FORWARD) for manual tuning back or forward.





SAVING RADIO CHANNEL TO MEMORY

1. If you want to save the current frequency into memory, press and hold ,  or  for more than 2 seconds. The station will be stored the to relevant button.

LISTENING TO SAVED RADIO MEMORY

1. Press the ,  or  button once to listen to the station stored in button.

SWITCH BETWEEN US & EURO FM MODES

1. Make sure dock and remote are turned on and in 'RADIO' mode.
2. Hold down the  (AUDIO) button for 3-5 seconds.
3. The remote will display 'AREA USA' or 'AREA EUR' depending on which tuning mode is currently selected.
4. Use the  &  buttons to switch between US or European modes.
5. Press  (PLAY/PAUSE) to select the desired tuning mode.
6. Once you switch modes it will default to the FM station stored in 'PRESET 1'.





 *US mode will increase and decrease the FM frequency in steps of 0.1 MHz, e.g. 88.5, 88.6, 88.7 MHz. EUR mode will increase and decrease the FM frequency in steps of 0.05 MHz, e.g. 88.25, 88.30, 88.35 MHz.*

PAIR WITH BLUETOOTH DEVICE

1. Switch on your Bluetooth device.
2. Select 'AQUATIC AV' from the list of available devices to pair (the password is "0000").

 Only one Bluetooth device can be paired with the Digital Media Locker at any time.

PLAY SONG FROM BLUETOOTH DEVICE

1. Bluetooth mode will be activated once a Bluetooth device is linked. 
2. Play the song from device and the sound will play through the Digital Media Locker.
3. Press  for play/pause.
4. Press  /  button to play previous/next song file.

EXTERNAL TRIGGER

Aquatic AV understands the need for more flexible remote applications. With the Digital Media Locker Aquatic AV has provided an independent 12V 'accessory' trigger, activated from the RF wireless remote. This could activate any 12V based device like 12V lights or surveillance camera.

1. In any operational mode, press the  (12V TRIGGER) key to activate. Press again to deactivate.
2. We strongly recommend you speak to our technical service staff or your dealer if you are considering using this feature.



Load on External Trigger should not exceed 350mA.

DEVICE CHARGING

When specified USB devices are connected to the USB connector the device battery will charge.

REMOTE CONTROL LCD AUTO OFF

To maximize battery life of the Remote Control, the LCD will be OFF if no key is pressed for 20 seconds. To re-activate the LCD display, press any key once to bring the remote control to normal operation.

TECHNICAL SPECIFICATIONS

Media

Supported media.....Bluetooth/USB/iPod/iPhone/MP3/FM
 Device charging.....via USB
 Device control.....via Door Controls & RF Remote Control

Inputs

USB/iPod/iPhone.....USB 2.0
 Auxilliary.....2x 3.5mm Stereo Jack Socket

Outputs

Pre-Out.....1x Stereo pair RCA (4V)

FM Radio

FM pre-sets.....3
 US/Euro frequencies.....Yes

Power

Output voltage @ 2 Ohm.....4x 72W
 Output voltage @ 4 Ohm.....4x 45W
 Operation voltage.....10.7V - 15.6V DC
 Max current draw.....7A
 Standby current draw.....4mA

Multi-environment Certifications

Waterproof / Dustproof.....Yes (IP65 Digital Media Locker™)
 Waterproof / Dustproof.....Yes (IP66 Remote Control)
 Conformal PCB coating.....Yes
 UV protection.....500 hours stable, ASTM D4329 compliant
 Salt/Fog protection.....500 hours stable, ASTM B117 compliant
 Stainless Steel mountings.....Yes

DIMENSIONS

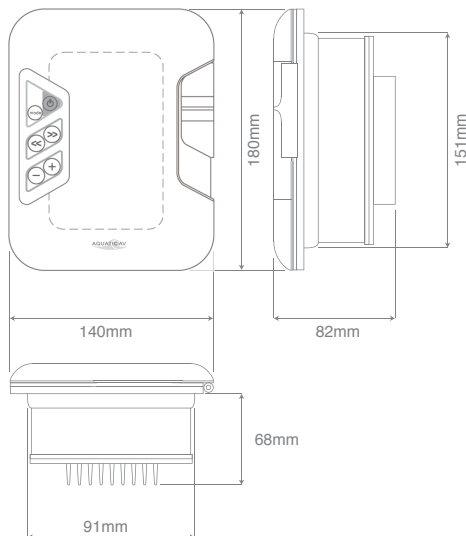

Aquatic AV offers a limited warranty of our products on the following terms:

Length of warranty

2 years on audio systems, electronics, speakers, and accessories (receipt required).

Coverage

This warranty covers only the original purchaser of a Aquatic AV product purchased from an authorized Aquatic AV dealer in the United States. In order to receive service, the purchaser must provide Aquatic AV with a copy of the receipt stating the customer name, dealer name, product purchased and date of purchase.

Defective products

Products found to be defective during the warranty period will be repaired or replaced (with a product deemed to be equivalent) at Aquatic AV's discretion.

What is not covered

Damage caused by accident, abuse, improper operations, water, theft. Any cost or expense related to the removal or reinstallation of product. Service performed by anyone other than an authorized Aquatic AV service center. Any product with the serial number or tamper labels defaced, altered, or removed. Subsequent damage to other components. Any product not purchased from an authorized Aquatic AV dealer.

Limit on implied warranties

Any implied warranties including warranties of fitness for use and merchantability are limited in duration to the period of the express warranty set forth above. Some states do not allow limitations on the length of an implied warranty, so this limitation may not apply. No person is authorized to assume for hawg wired any other liability in connection with the sale of the product.

How to obtain service

You must obtain a return material authorization number (RMA) to return any product to Aquatic AV. You are responsible for shipping charges of returned products to Aquatic AV.

Please record the model and serial number[s] of your equipment in the space provided below as your permanent record and will assist us with your factory warranty coverage. These numbers can be found on the rear of the Digital Media Locker.

Model number[s]:	Serial number[s]:

FCC ID:
MADE IN CHINA

This device complies with Part 15 of the FCC Rules. Operation is subject to the following two conditions: (1) this device may not cause harmful interference, and (2) this device must accept any interference received, including interference that may cause undesired operation.

NOTE:

The equipment has been tested and found to comply with the limits for a Class B digital device, pursuant to Part 15 of the FCC Rules. These limits are designed to provide reasonable protection against harmful interference in a residential installation. This equipment generates, uses and can radiate radio frequency energy and, if not installed and used in accordance with the instructions, may cause harmful interference to radio communications. However, there is no guarantee that interference will not occur in a particular installation.

If this equipment does cause harmful interference to radio or television reception, which can be determined by turning the equipment off and on, the user is encouraged to try to correct the interference by one or more of the following measures:

- Reorient or relocate the receiving antenna.
- Increase the separation between the equipment and receiver.
- Consult the dealer or an experienced radio/TV technician for help.

The manufacturer is not responsible for any radio or TV interference caused by unauthorized modifications to this equipment. Such modifications could void the user authority to operate the equipment.

Aquatic AV

282 Kinney Drive
San Jose, CA 95112, USA

E-mail: info@aquaticav.com

US & Canada: 1 877 579 2782

International: +1 408 559 1668

Fax: +1 408 559 0125

www.aquaticav.com

