



products with a watertight reputation

DIGITAL MEDIA LOCKER™

AQ-DM-3B

OWNERS MANUAL

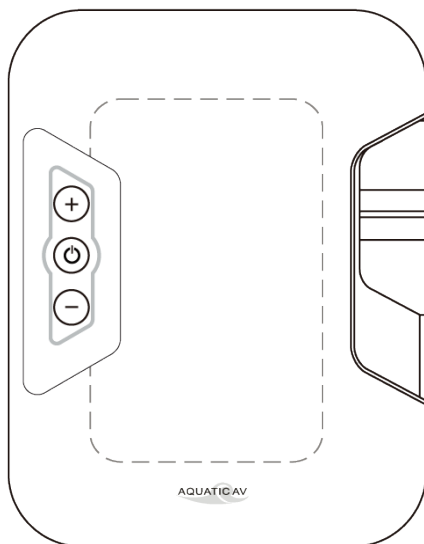

AQ-DM-3B

DIGITAL MEDIA LOCKER™

for MP3 devices



PLEASE READ THIS INSTRUCTION MANUAL BEFORE INSTALLATION
AND OPERATION

CONTENTS

- AQ-DM-3B Digital Media Locker™
- 3.5mm to 3.5mm Jack Cable
- Wiring Harness (AQ-UNH-2)
- Six (6) Stainless Steel mounting screws
- Mounting template
- Owners Manual

INSTALLATION

1. 12-pin Watertight Harness

The 12-pin harness supplies power and ground connections to the Digital Media Locker and four (4) speaker channel output connections from the Digital Media Locker.



Do not cut or modify the 12-pin harness on the Locker side or warranty will be void.

2. Auxiliary Output

Allows external amplifiers to be connected to power additional speakers.

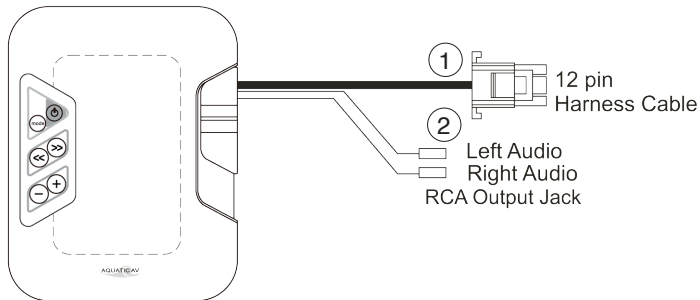

12-PIN HARNESS CONNECTION

The AQ-DM-3B includes the universal harness AQ-UNH-2 in order to connect the dock to power and speakers.

All open wire connections should be soldered and protected against water and dust for best long term performance.

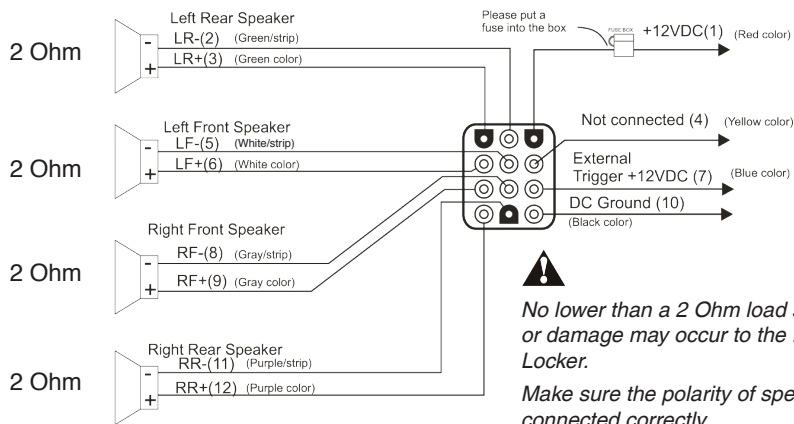

MOUNTING THE UNIT

1. Mounting templates are included. Aquatic AV recommends using the 'measure twice, cut once' method.

2. Once the mounting hole is complete, make sure the outside surface is clean and clear of debris. The Digital Media Locker has an external water/dust proof gasket, but this requires a clean surface for best performance.

3. The Digital Media Locker has six (6) front screws. Drive the screws using a screw driver. During final mounting apply equal pressure to all points for the best water/dust outer seal performance.

4. Review all outside surfaces of the Digital Media Locker to ensure proper water/dust seal. This is important for long term environmental protection performance for your digital media device.

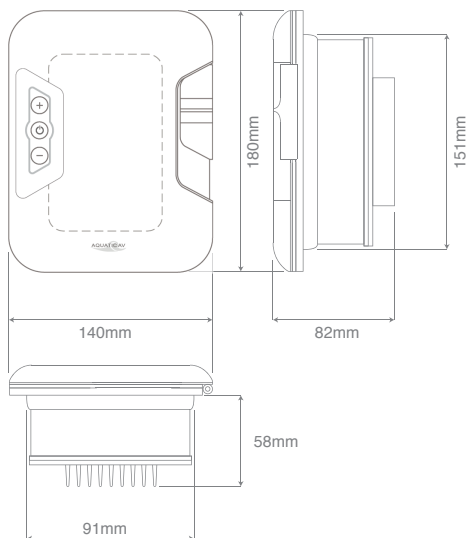

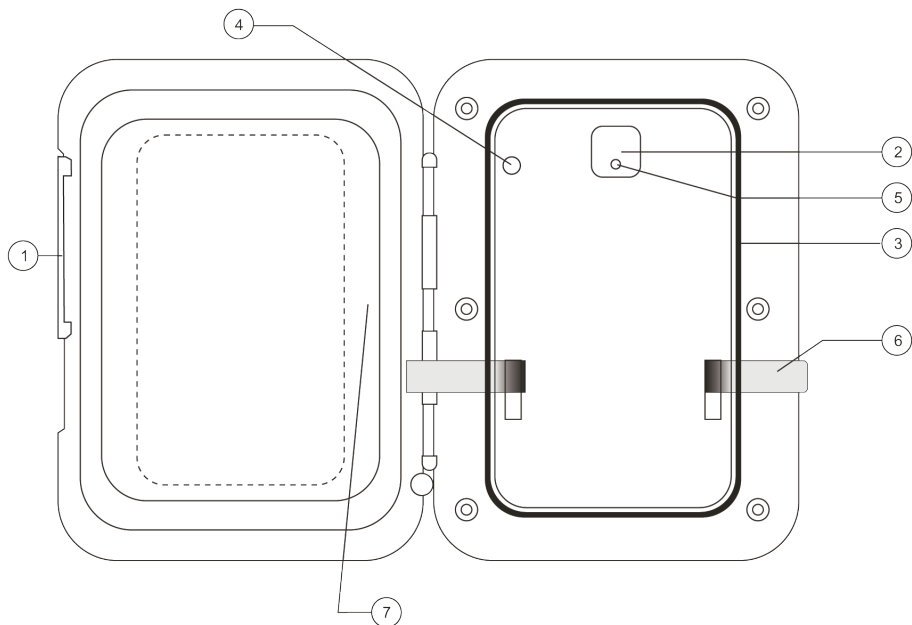

DIGITAL MEDIA LOCKER



1. Digital Media Locker Open/Close Latch & Protective Door
2. Power ON/OFF Button
3. Water/Dust Protection Inner Gasket
4. 3.5mm Aux Input for MP3 Devices
5. Power ON/OFF LED
6. Security Strap for digital media devices
7. Door Control Keypad

DOOR CONTROL KEYPAD

Power		Press once: Toggle from Operation mode to Standby mode or vice-versa.
Volume Up		Press once: Volume up Press and hold: Fast volume up
Volume Down		Press once: Volume down Press and hold: Fast volume down

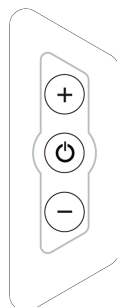

POWER ON

Press the on/off button. ON will be indicated by a red LED.

For applications that require zero current draw, and where battery drain may occur, the power button must be turned OFF. When the power button is in the OFF position the red LED will not be lit.

For applications where a 12V battery is not used, such as in a Spa, the power button can be left ON and the remote control can then be used to power on/off accordingly.





LISTENING VIA 3.5MM JACK

1. Power up the Digital Media Locker.
2. Attach your MP3 device to the 3.5mm connector.
3. Secure the device with the anchor straps provided.
4. Secure the Digital Media Locker's protective door.



Always ensure to connect and disconnect your media player with dry hands!

ADJUST VOLUME LEVEL

1. Press  (VOLUME UP) once to increase the volume by 3 decibels.
2. Press  (VOLUME DOWN) once to reduce the volume by 3 decibels.
3. Press and hold either  or  and the Digital Media Locker will increase or decrease audio volume continuously.

TECHNICAL SPECIFICATIONS

Media

Supported media.....MP3
 Device control.....via Door Controls

Inputs

Auxilliary.....3.5mm Stereo Jack Socket

Outputs

Pre-Out.....1x Stereo pair RCA (4V)

Power

Output voltage @ 2 Ohm.....4x 72W
 Output voltage @ 4 Ohm.....4x 45W
 Operation voltage.....10.7V - 15.6V DC
 Max current draw.....7A
 Standby current draw.....4mA

Multi-environment Certifications

Waterproof / Dustproof.....Yes (IP65)
 Conformal PCB coating.....Yes
 UV protection.....500 hours stable, ASTM D4329 compliant
 Salt/Fog protection.....500 hours stable, ASTM B117 compliant
 Stainless Steel mountings.....Yes

DIMENSIONS

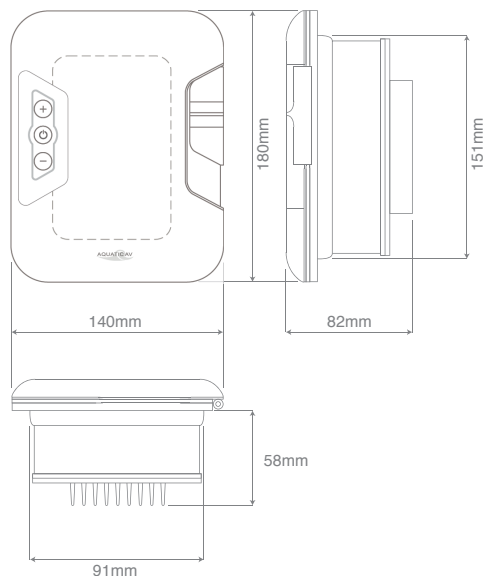

WARRANTY INFORMATION

Aquatic AV offers a limited warranty of our products on the following terms:

Length of warranty

2 years on audio systems, electronics, speakers, and accessories (receipt required).

Coverage

This warranty covers only the original purchaser of a Aquatic AV product purchased from an authorized Aquatic AV dealer in the United States. In order to receive service, the purchaser must provide Aquatic AV with a copy of the receipt stating the customer name, dealer name, product purchased and date of purchase.

Defective products

Products found to be defective during the warranty period will be repaired or replaced (with a product deemed to be equivalent) at Aquatic AV's discretion.

What is not covered

Damage caused by accident, abuse, improper operations, water, theft. Any cost or expense related to the removal or reinstallation of product. Service performed by anyone other than an authorized Aquatic AV service center. Any product with the serial number or tamper labels defaced, altered, or removed. Subsequent damage to other components. Any product not purchased from an authorized Aquatic AV dealer.

Limit on implied warranties

Any implied warranties including warranties of fitness for use and merchantability are limited in duration to the period of the express warranty set forth above. Some states do not allow limitations on the length of an implied warranty, so this limitation may not apply. No person is authorized to assume for hawg wired any other liability in connection with the sale of the product.

How to obtain service

You must obtain a return material authorization number (RMA) to return any product to Aquatic AV. You are responsible for shipping charges of returned products to Aquatic AV.

Please record the model and serial number[s] of your equipment in the space provided below as your permanent record and will assist us with your factory warranty coverage. These numbers can be found on the rear of the Digital Media Locker.

Model number[s]:	Serial number[s]:

FCC STATEMENT:

FCC ID:
MADE IN CHINA

This device complies with Part 15 of the FCC Rules. Operation is subject to the following two conditions: (1) this device may not cause harmful interference, and (2) this device must accept any interference received, including interference that may cause undesired operation.

NOTE:

The equipment has been tested and found to comply with the limits for a Class B digital device, pursuant to Part 15 of the FCC Rules. These limits are designed to provide reasonable protection against harmful interference in a residential installation. This equipment generates, uses and can radiate radio frequency energy and, if not installed and used in accordance with the instructions, may cause harmful interference to radio communications. However, there is no guarantee that interference will not occur in a particular installation.

If this equipment does cause harmful interference to radio or television reception, which can be determined by turning the equipment off and on, the user is encouraged to try to correct the interference by one or more of the following measures:

- Reorient or relocate the receiving antenna.
- Increase the separation between the equipment and receiver.
- Consult the dealer or an experienced radio/TV technician for help.

The manufacturer is not responsible for any radio or TV interference caused by unauthorized modifications to this equipment. Such modifications could void the user authority to operate the equipment.

Specifications are subject to change. All rights reserved. Made in China.
Digital Media Locker is a trademark of Aquatic AV.

Doc V1.0



Aquatic AV

282 Kinney Drive
San Jose, CA 95112, USA

E-mail: info@aquaticav.com

US & Canada: 1 877 579 2782

International: +1 408 559 1668

Fax: +1 408 559 0125

www.aquaticav.com

